

Features

- Low voltage drop: 0.18V@100mA
- High input voltage: 25V
- Low temperature coefficient
- Large Output Current: >0.4A
- Low Quiescent Current: 2.0uA
- Output voltage accuracy: tolerance ±1%
- Built-in current limiter
- SOT89,SOT23 and SOT23-3packages

Applications

- Battery-powered equipment
- Hand-Hold Equipment
- GRS Receivers
- Wireless LAN

General Description

The HE2031 series is a group of positive voltage output, three-pin regulators, it provide a high current even when the input/output voltage differential is small. Low power consumption and high accuracy is achieved through CMOS and laser trimming technologies.

The HE2031 consists of a high-precision voltage reference, an error amplification circuit, and a current limited output driver. Load Transient response has improved in comparison to the existing series. SOT89, SOT23-3 and SOT23 packages are available.

Selection Table

Part No.	Output Voltage	Package	Marking
HE2031A25Mxx	2.5V	SOT89 SOT23-3 SOT23	Refer to Marking rule
HE2031A28Mxx	2.8V		
HE2031A30Mxx	3.0V		
HE2031A33Mxx	3.3V		
HE2031A36Mxx	3.6V		
HE2031A40Mxx	4.0V		
HE2031A45Mxx	4.5V		
HE2031A50Mxx	5.0V		

Order Information

HE2031A①②③④⑤

Designator	Symbol	Description
①②	Integer	Output Voltage(1.8~5.0V)
③	M	Standard
④	P	Package:SOT89
	M	Package:SOT23-3
	M3	Package:SOT23
⑤	R	RoHS / Pb Free
	G	Halogen Free

Note: "①②" stands for output voltages. Other voltages can be specially customized

Block Diagram

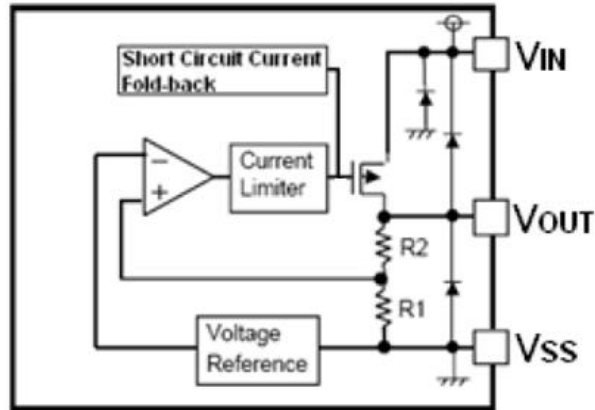

Pin Assignment

SOT23,SOT23-3(Top View)

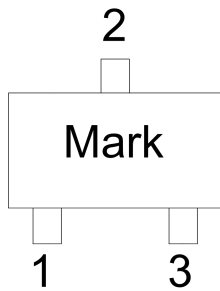

Table1: HE2031AXXMMR series (SOT23,SOT23-3 PKG)

PIN NO.	PIN NAME	FUNCTION
1	GND	GND pin
2	VIN	Input voltage pin
3	VOUT	Output voltage pin

SOT89 (Top View)



Table2: HE2031AXXMPR series (SOT89 PKG)

PIN NO.	PIN NAME	FUNCTION
1	GND	GND pin
2	VIN	Input voltage pin
3	VOUT	Output voltage pin

Marking Rule

SOT23-3 and SOT89

SOT23-3 (Top View)

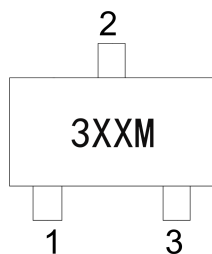

SOT89 (Top View)

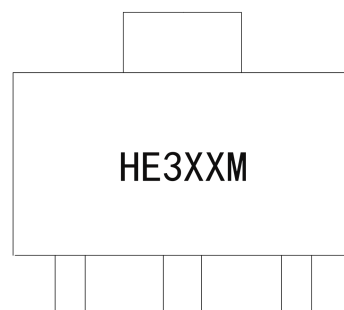

Absolute Maximum Ratings

Supply Voltage1.5V to 25V Storage Temperature-40°C to 125°C
 Operating Temperature-40°C to 85°C

Note: These are stress ratings only. Stresses exceeding the range specified under “Absolute Maximum Ratings” may cause substantial damage to the device. Functional operation of this device at other conditions beyond those listed in the specification is not implied and prolonged exposure to extreme conditions may affect device reliability.

Electrical Characteristics

HE2021 for any output voltage

(Ta=25°C)

Parameter	Symbol	Conditions	Min.	Typ.	Max.	Unit
Output Voltage	Vout	Vin=Vout+1V 1.0mA≤Iout≤30mA	Vout×0.99	--	Vout×1.01	V
Output Current*1	Iout	Vin-Vout=1V	--	400	--	mA
Low dropout*2	Vdrop	Refer to the next table				
Line Regulation	$\frac{\Delta V_{OUT}}{\Delta V_{IN} \times V_{OUT}}$	1.6V≤Vin≤8V Iout=100mA	--	0.05	0.2	%/V
Load Regulation	ΔVout	Vin= Vout+1V 1.0mA≤Iout≤100mA	--	12	30	mV
Output voltage Temperature Coefficiency	$\frac{\Delta V_{OUT}}{\Delta Ta}$	Iout=30mA 0°C≤Ta≤70°C	--	±100	--	Ppm/°C
PSRR	PSRR	F=1KHz Vin=Vout+1V	--	60	--	dB
Supply Current	Iss1	--	--	1	2	uA
Input Voltage	Vin	--	--	--	25	V

Electrical Characteristics by Output Voltage:

Output Voltage Vout(V)	Dropout Voltage Vdif (V)		
	Conditions	Typ.	Max.
Vout ≤ 2.0V	Iout=60 mA	0.1	0.12
2.0 < Vout ≤ 3.0	Iout=80 mA	0.12	0.14
3.0 < Vout ≤ 4.0	Iout=100 mA	0.16	0.18
4.0 < Vout ≤ 5.0		0.17	0.18
3.0 < Vout ≤ 4.0	Iout=200 mA	0.21	0.24
4.0 < Vout ≤ 6.0		0.20	0.22
3.0 < Vout ≤ 4.0	Iout=400 mA	0.8	0.85
4.0 < Vout ≤ 6.0		0.75	0.80

Typical Application

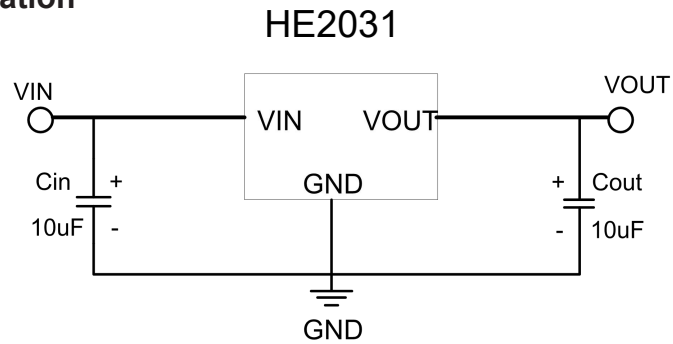

Note1: $C_{in}=C_{out}=10\mu F$. (10uF Electrolytic capacitor is recommended).

Note2: If the input and output capacitors are ceramic, add a resistor at the input, as follows.

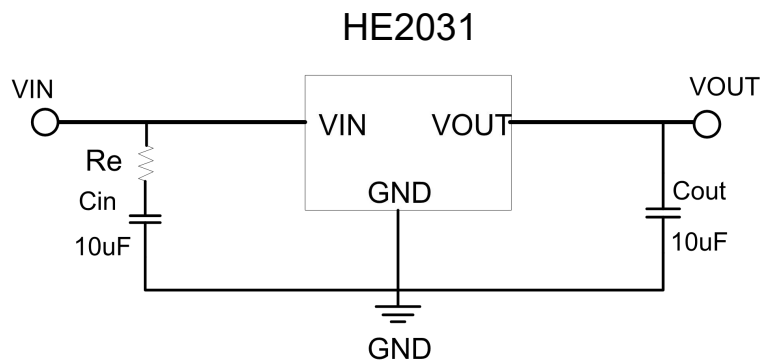

Note: $R_e = (1.2 \sim 1.8) \Omega$.

Package Information
3-pin SOT89 Outline Dimensions

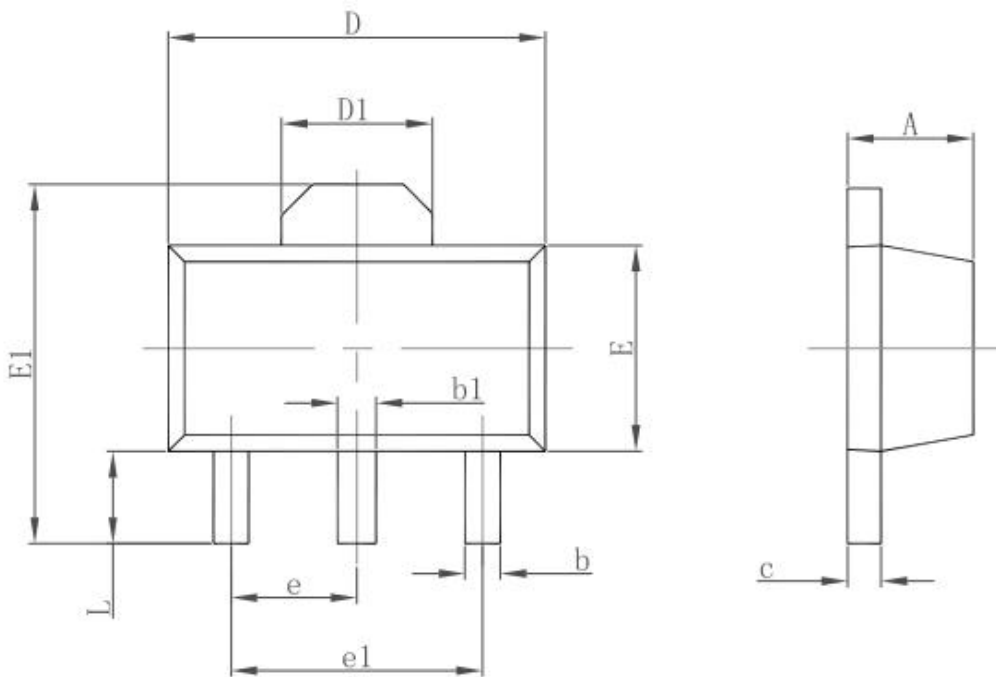

Symbol	Dimensions In Millimeters		Dimensions In Inches	
	Min.	Max.	Min.	Max.
A	1.400	1.600	0.055	0.063
b	0.320	0.520	0.013	0.020
b1	0.400	0.580	0.016	0.023
c	0.350	0.440	0.014	0.017
D	4.400	4.600	0.173	0.181
D1	1.550 REF.		0.061 REF.	
E	2.300	2.600	0.091	0.102
E1	3.940	4.250	0.155	0.167
e	1.500 TYP.		0.060 TYP.	
e1	3.000 TYP.		0.118 TYP.	
L	0.900	1.200	0.035	0.047

3-pin SOT23-3 Outline Dimensions

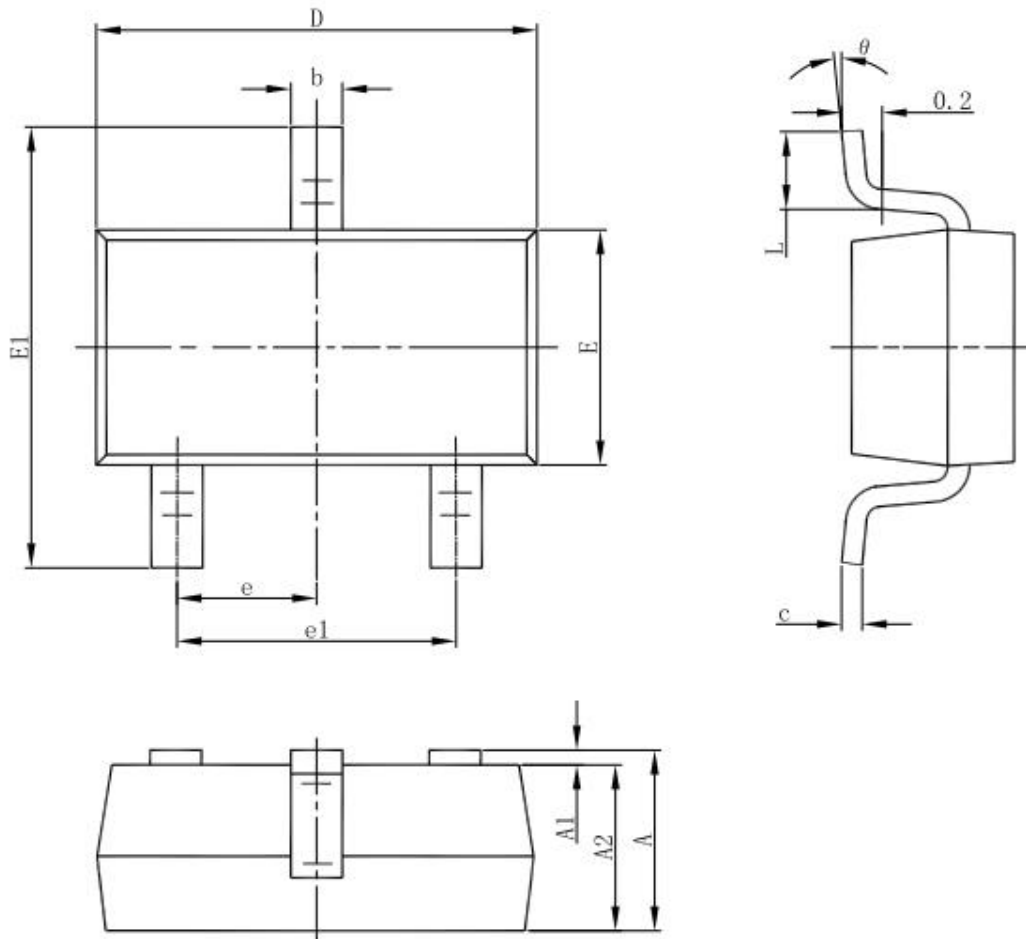

Symbol	Dimensions In Millimeters		Dimensions In Inches	
	Min	Max	Min	Max
A	1.050	1.250	0.041	0.049
A1	0.000	0.100	0.000	0.004
A2	1.050	1.150	0.041	0.045
b	0.300	0.500	0.012	0.020
c	0.100	0.200	0.004	0.008
D	2.820	3.020	0.111	0.119
E	1.500	1.700	0.059	0.067
E1	2.650	2.950	0.104	0.116
e	0.950(BSC)		0.037(BSC)	
e1	1.800	2.000	0.071	0.079
L	0.300	0.600	0.012	0.024
theta	0°	8°	0°	8°